

RoHS

壓花螺絲

內六角螺絲



L(左側),  
行程15~35

R(右側),  
行程15~35

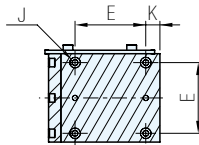
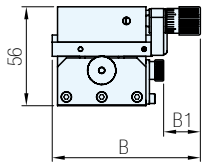
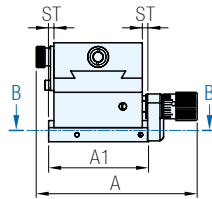
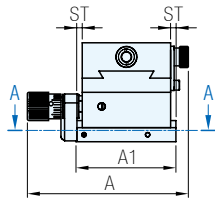
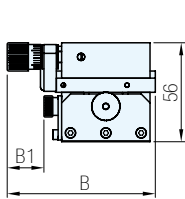
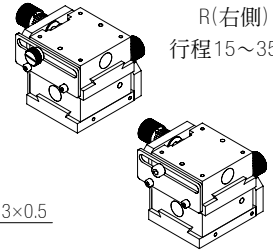
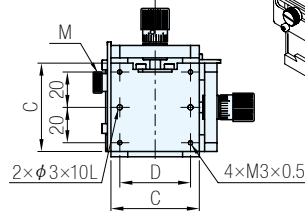
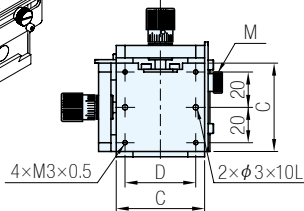
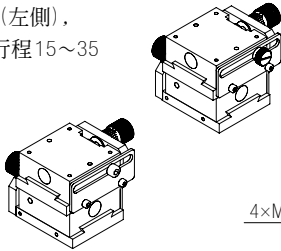

A-A

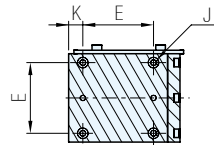

B-B

L(左側),  
行程60

R(右側),  
行程60

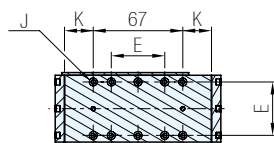
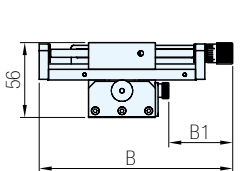
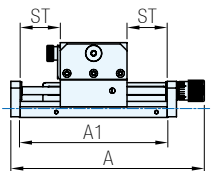
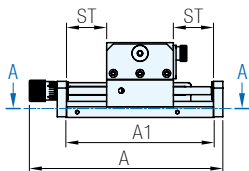
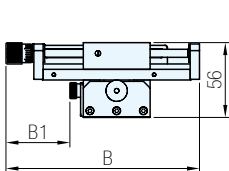
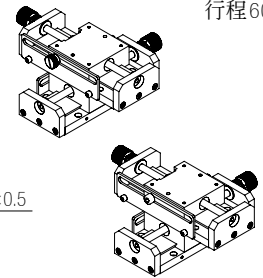
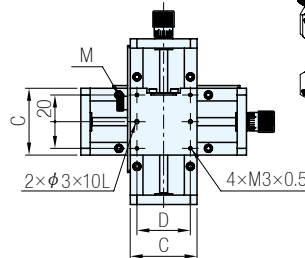
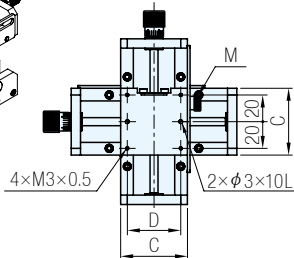
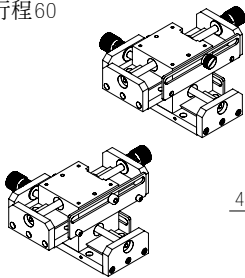

A-A

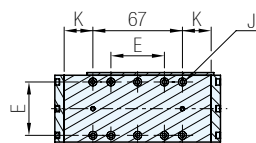

B-B

L(左側),  
行程80

R(右側),  
行程80

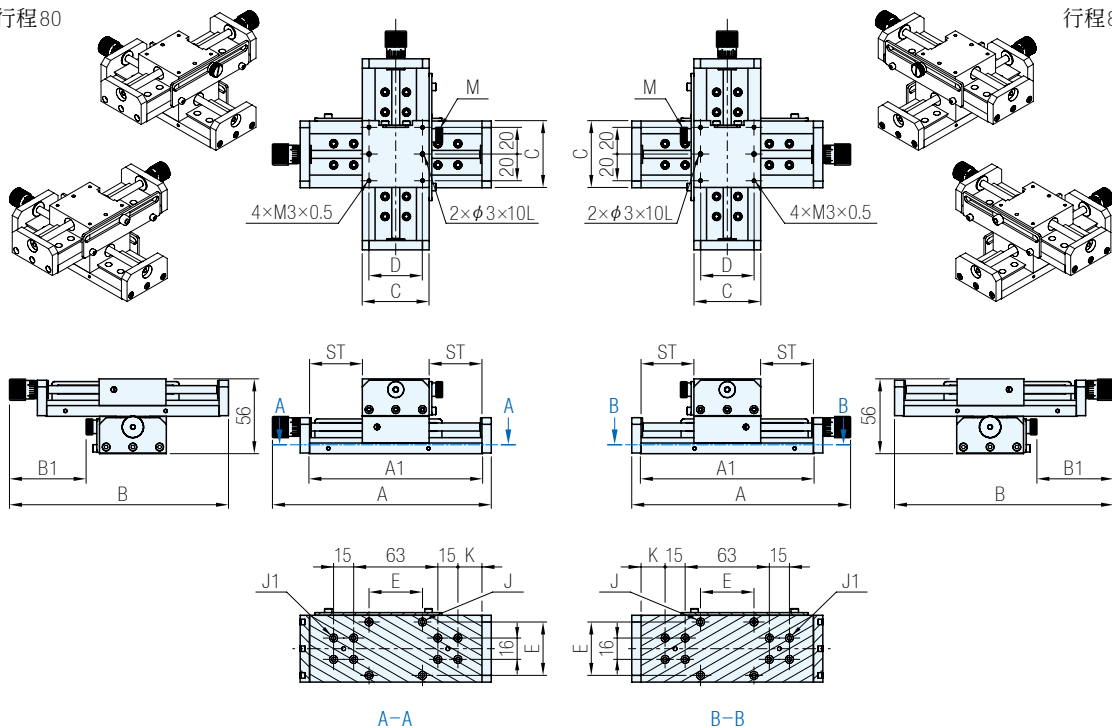

品號	檯面 C	A	A1	B	B1	D	E	J	J1	K	ST	行程	M 固定螺絲	軸位
AFG-0012	50	( 88)	56.5	( 84)	(24 )	40	40	表面4×φ6 深3.5沉孔, M4×0.7P(貫穿)	-	8.0	3.0	15	內六角螺絲	L(左側)
AFG-0013					R(右側)									
*AFG-0032		( 91)		(21 )	壓花螺絲								L(左側)	
*AFG-0033			R(右側)											
AFG-0016		( 94)	66.5	( 94)	(29 )								內六角螺絲	L(左側)
AFG-0017					R(右側)									
*AFG-0036		( 96)								(26 )	壓花螺絲	L(左側)		
*AFG-0037					R(右側)									
AFG-0020					-					內六角螺絲	L(左側)			
AFG-0021		(110)	82.5	(110)	(34 )						R(右側)			
*AFG-0040										壓花螺絲	L(左側)			
*AFG-0041											R(右側)			
AFG-0024					(51 )					內六角螺絲	L(左側)			
AFG-0025		(145)	111.0	(145)	(48 )						R(右側)			
*AFG-0044										壓花螺絲	L(左側)			
*AFG-0045											R(右側)			
AFG-0028					(60.5)					內六角螺絲	L(左側)			
AFG-0029		(164)	130.0	(164)	(57.5)						R(右側)			
*AFG-0048					壓花螺絲	L(左側)								
*AFG-0049						R(右側)								

**Ps. 備註**

- 材質、規格表等詳細資料請參閱AFG首頁
- \* 記號側邊鎖固螺絲標配壓花螺絲,可用一字起子或手直接調整;可改選成內六角螺絲,請洽詢
- 行程15的產品鎖固方式為背鎖

訂貨: 品號 交期: 14 天

AFG-0012